

Comparison of PID and Fuzzy Controller for Position Control of AR.Drone

A Prayitno¹, V Indrawati² and I I Trusulaw³

^{1,2,3} Electrical Engineering Department, University of Surabaya (UBAYA)
Raya Kalirungkut, Surabaya 60293, East Java, Indonesia, Tel.+62-31-2981157

¹ prayitno_agung@staff.ubaya.ac.id

Abstract. This paper describes the implementation of the PID Controller to control the position of the AR.Drone in the x-y-z. This position control scheme uses three PID controllers to maintain the position of x, y and z using the signal control pitch, roll and vertical rate. PID Controller implemented on AR.Drone 2.0 and then tested in an indoor space. The performance of the controller will be compared with Fuzzy Logic Controller schemes that have been implemented previously. The results show that the PID Controller generate a response with rise time less than 3 seconds at the x and y position with around 25% overshoot. The result for z position give better result without overshoot. The comparison between fuzzy logic and PID Controller indicates that the results of the PID controller is better although there is overshoot.

1. Introduction

Currently, the AR.Drone is widely used by researchers for its research platform. AR.Drone was chosen because it is relatively inexpensive but has onboard controller and internal software. AR.Drone body constructs from frame which made of carbon pipe with 4 brushless motors complete with propellers and the main body is made of plastics fiber in which there are onboard electronics and Lithium-Polymer (Li-Po) battery. User can access controller via Wi-Fi communication. The onboard controller consists of motherboard and navigation board. On the motherboard, there are the processor, front camera, bottom camera, and Wi-Fi chips. On the navigation board there is a microcontroller board that use as an interface to the sensors. AR.Drone equipped with accelerometer, gyroscope and ultrasonic altimeter [1].

AR.Drone maneuver can be controlled using 4 control signals (values between -1 and 1): pitch (positive values for backward, negative values for forward), roll (positive values for move to right, negative values for move to left), yawrate (positive values for the movement pivot clockwise, negative values for the movement pivot counterclockwise) and vertical rate (positive values for vertical rate to up, negative values for vertical rate to down). Moreover, there are 3 toggle switches for fly, hover and emergency command. Navigation data can be accessed from the AR.Drone includes the actual pitch, forward speed, actual roll, sideward speed, actual yaw, vertical speed, altitude, and time stamp. Using this data we can estimate the x,y,z position of the drone. Figure 1 show the inputs and outputs of the AR.Drone system.



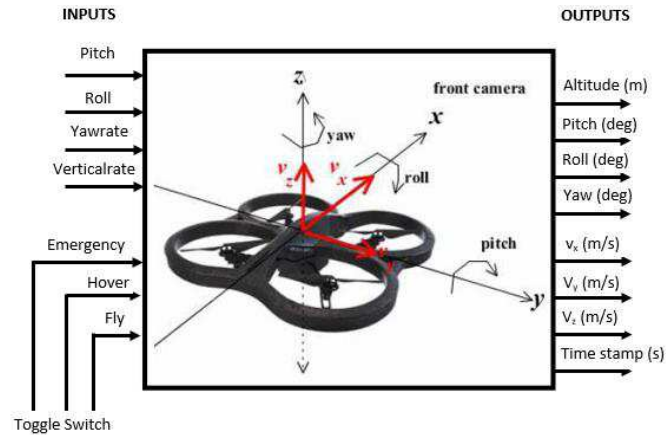

Figure 1. AR.Drone Inputs – Outputs.

Many studies have described a variety of development and application using the AR.Drone. Michael [2] created LabVIEW Toolkits consisting of Main VI, Video VI, NavData VI, and Additional Supporting VI to control the AR.Drone. This software has the ability to transmit control commands and keep the communication channel running, read UDP packets that contain video frame sent from the AR.Drone, sends UDP packets that contain sensor's navigation data output to the IP address of the computer and estimate x , y , z position of the navigation data. Krajnik [3] formulated four AR.Drone structure models which has input output relations: setpoint pitch - actual pitch - forward speed; setpoint roll - actual roll - sideward speed, setpoint yaw rate - actual yaw rate - yaw, and setpoint vertical rate - actual rate vertical - altitude. Agung [4] calculated model of roll, pitch, yaw rate and critical rate with a step response test on the AR.Drone 1.0. Sarah [5] identified the model parameters of the internal and dynamic model of AR.Drone using second order system approach. Some control scheme are designed and implemented the the model obtained. The control schemes are waypoint navigation controller, leader-follower behavior, trajectory-following behavior. Agung [6] designed a fuzzy scheme trajectory tracking control for applications in x - y coordinates. This fuzzy scheme has two inputs that distance, angle and has two outputs, namely pitch, yawrate. Fuzzy control scheme tested on straight and curved trajectory. Veronica [7] implemented fuzzy logic control for waypoint navigation applications. This fuzzy scheme uses three fuzzy logic to control pitch, roll and vertical rate respectively with each input in the form of desired position and the actual position. Three scenarios were designed and implemented for the waypoint problem. The test results indicate that the fuzzy scheme can be used for waypoint applications. Veronica [8] implemented position control of ar.drone by using two fuzzy control. The first fuzzy used to control pitch and yawrate simultaneously with the input of distance and angle, while the fuzzy second is used to control the vertical rate using the input of desired and actual position z .

This paper reports the development of the PID controller scheme to control the position of the AR.Drone in the x - y - z . The result then compares with fuzzy control schemes that have been implemented in [8].

2. PID Controller Design

The design of PID Controller that will be implemented in this study is shown in figure 2. It can be seen that each position x , y and z of the drone will be controlled by individual PID. Input of each PID is error x , error y and error z , and the output is pitch, roll and vertical rate respectively. In this paper, PID controller design procedure is as follows:

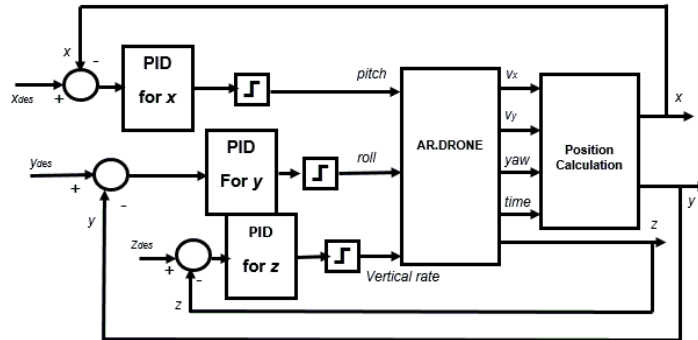

Figure 2. Block diagram of control system.

- Understanding the dynamics of the system AR.Drone. To understand the dynamics of the system, do the step response test on the system pitch, roll and vertical rate of AR.Drone by giving a value ranging from -1 up to 1. Navigation data such as actual pitch, forward speed, x, actual roll, sideward speed, y, vertical rate, and z are recorded and analyzed.
- From the data obtained, considering the limitations of indoor space there should be restrictions on the control signals. Pitch in the range of -0.115 to 0.115, roll in range of -0.125 to 0.125
- Formulate each subsystem PID controller, figure 3, into a computer program. For easy programming and implementation, the PID equation converted as follow.

$$PID = K_P e(t) + K_I \int e(t) + K_D \frac{de(t)}{dt} \quad (1)$$

$$PID = K_P * error + (K_I * integral * dt) + (K_D * \frac{derr}{dt}) \quad (2)$$

where:

K_P : Proportional Constant

K_I : Integral Constant

K_D : Derivative Constant

$error = desired\ point - actual\ point$

$integral = integral_{previous} + error$

$derr = error - error_{previous}$

dt : execution time

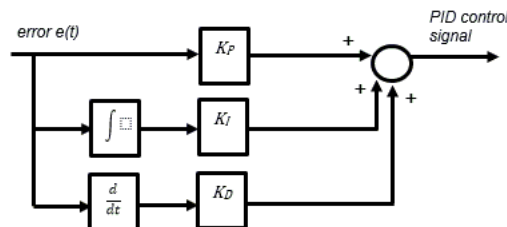

Figure 3. Block diagram of PID.

- Realize the system into computer program, block diagram and front panel.
- By trial and error, tune the PID parameter until obtain the best response. The obtained parameter is tabulated in table 1.

Table 1. PID Parameters.

Parameters	Values		
	PID for pitch	PID for roll	PID for vertical rate
Kp	1.6	1.6	1
Ki	0.005	0.005	1
Kd	0.5	0.5	2

3. Results and Analysis

PID controller is implemented on the AR.Drone 2.0 and flown at indoor laboratory. The testing process is conducted as follows:

- From the front panel, specify the setpoint position x , y and z , which are trying to reach by the AR.Drone.
- With the push button on the front panel, AR.Drone fly hover as high as 1 m. The hover position is considered as the initial coordinat (0,0,0).
- Then switch OFF hover in front panel, AR.Drone will fly autonomous with PID Controller designed to the setpoint. During flew the flight data is recorded.
- When it reaches the intended position, indicated hover fly, AR.Drone is landed.

The results of four time testing at the set point (1,1,1) are shown in figure 4 and figure 5. Figure 4 are 3-D representation, while figure 5 is 2-D representation of the AR.Drone response.

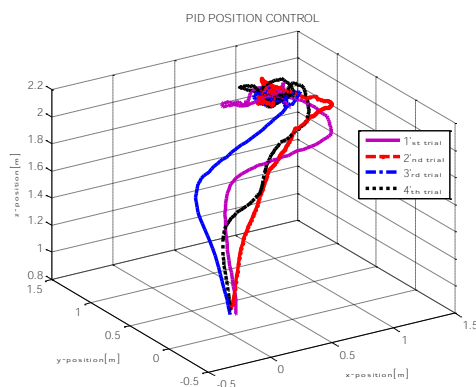

Figure 4. Experiment result of PID Position Control in 3-D.

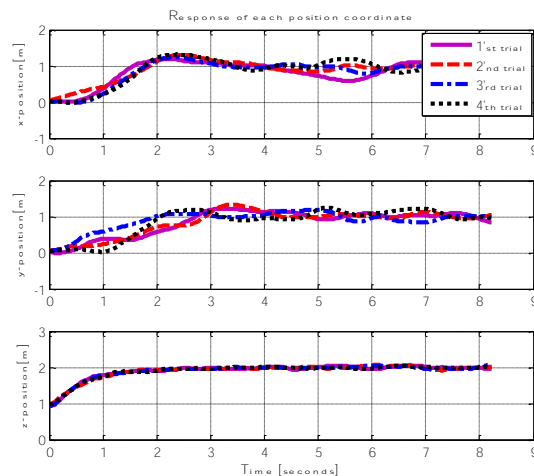

Figure 5. Experimental results of PID Position Control in 2-D.

From the test results, figure 5, it appears that the AR.Drone can reach the desired position with a rise time of about 2 seconds, has about 25% overshoot and settling time of about 4 seconds. From 3-D graphics, figure 4, it appears that the AR.Drone experienced oscillations around the setpoint.

Tests were also done on the set point (1,1,0) to see the response AR.Drone in flight the x-y plane. The results of four time testing are shown in figure 8.

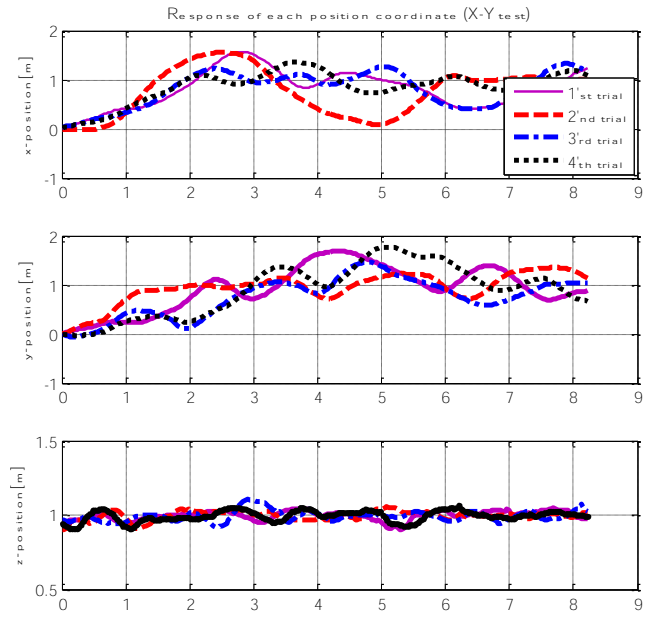

Figure 6. Experimental results of PID Position Control in 2-D.

4. Comparison with Fuzzy Control Scheme

Results PID position control is compared with the Fuzzy position test control implemented by Veronica [8], where the fuzzy scheme is shown in figure 7 and figure 8:

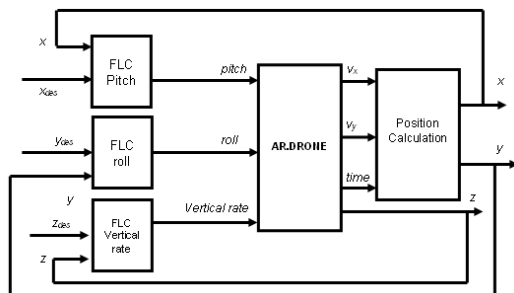

Figure 7. First fuzzy scheme implemented on [8].

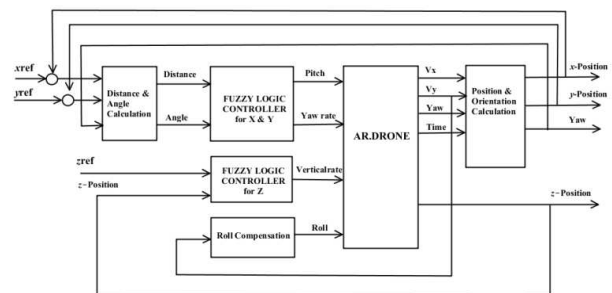

Figure 8. Second fuzzy scheme implemented on [8].

Similar to the PID Controller scheme, scheme in figure 7, uses three pieces of FLC controller to control pitch, roll and vertical rate simultaneously. Each fuzzy input is the desired position and the actual position. While scheme in figure 8 uses only two pieces of fuzzy control for pitch and yawrate simultaneously and fuzzy logic for the vertical rate.

The results of the comparison PID response with two fuzzy schemes that has been done is shown in figure 9. It is noticeable that the PID controller generates a better response both in the x, y and z, but has a slightly higher overshoot

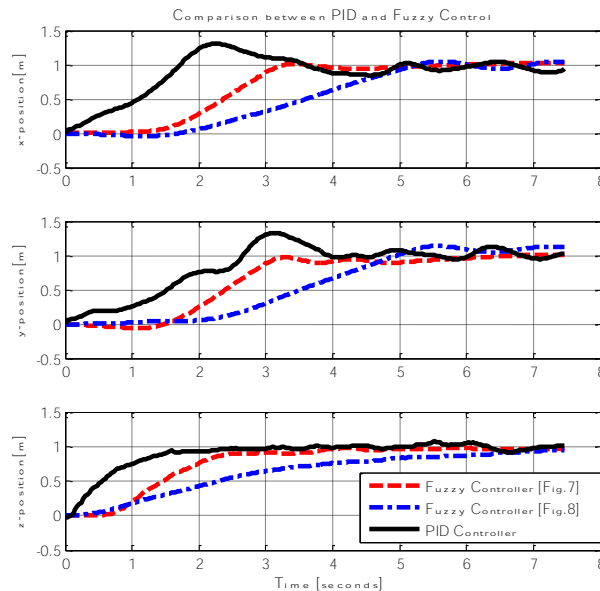

Figure 9. Comparison of two control schemes.

5. Conclusion

To control position of x , y , z of the AR.Drone can be realized with three PID controller to manipulate the pitch, roll and vertical rate. The implementation results show that PID controlled system gives response with a rise time of about 2 seconds, 25% overshoot and settling time of about 4 seconds. The results of the comparison between PID controlled system and fuzzy controlled system, the PID controlled system gives better result in this experiment.

References

- [1] Pierre-Jean B, Francois C, David V and Nicolas P 2011 The navigation and control technology inside the AR drone micro UAV 18th IFAC World Congress Milano Italy
- [2] Michael M 2012 The AR drone LabVIEW toolkit: A software framework for the control of low cost quadrotor aerial robots (Master of Science Thesis - TUFTS University)
- [3] Krajnik T, Vonasek V, Fiser D and Faigl J 2011 AR-drone as a platform for robotic research and education. Research and Education in Robotics EUROBOT Heidelberg
- [4] Agung P and Veronica I 2014 Model AR.drone dengan indoor dan outdoor Hull Proceeding CITEE Yogyakarta Indonesia.
- [5] Sarah Y Tang 2013 Vision-based control for autonomous quadrotor (Final Report :Undergraduated Senior Thesis. Department of Mechanical and Aerospace Engineering. Princeton University)
- [6] Agung P, Veronica I and Gabriel U 2014 Trajectory tracking of AR.drone quadrotor using fuzzy logic controller J. Telkomnika 12(4) 819
- [7] Veronica I, Agung P and Thomas A Kurniawan 2015 Waypoint navigation of AR.drone quadrotor using fuzzy logic controller J. Telkomnika 13(3) 930
- [8] Veronica I, Agung P and Gabriel U 2015 Comparison of two fuzzy logic controller schemes for position control of AR.drone *Proceeding of 7th International Conference on Information Technology and Electrical Engineering (ICITEE)* Chiangmai Thailand

ISSN 1757-8981

IOP Conference Series

Materials Science and Engineering

2nd International Conference
on Robotics and Mechantronics

517

VOLUME 517 – 2019

5–11 November 2018
Singapore

EDITOR
Meng Joe G

The open access journal for conference proceedings
iopscience.org/jpcs

IOP Publishing

 **NOTICE:** Ukraine: Click here to read IOP Publishing's statement.

Table of contents

Volume 190

2017

◀ Previous issue Next issue ▶

**IAES International Conference on Electrical Engineering, Computer Science and Informatics
23–25 November 2016, Semarang, Indonesia**

Accepted papers received: 31 March 2016

Published online: 19 April 2017

Open all abstracts

Preface

OPEN ACCESS 011001

IAES International Conference on Electrical Engineering, Computer Science and Informatics

Munawar A Riyadi, SAD Prasetyowati, T Sutikno and D Stiawan

+ Open abstract  View article  PDF

OPEN ACCESS 011002

Foreword from Chair of EECSI 2016

+ Open abstract  View article  PDF

OPEN ACCESS 011003

Peer review statement

+ Open abstract  View article  PDF

Papers

OPEN ACCESS 012001

Differential-Drive Mobile Robot Control Design based-on Linear Feedback Control Law

Siti Nurmaini, Kemala Dewi and Bambang Tutuko

+ Open abstract  View article  PDF

-
- OPEN ACCESS** 012002
Conveyor Performance based on Motor DC 12 Volt Eg-530ad-2f using K-Means Clustering
Zaenal Arifin, Sri DP Artini and Imam Much Ibnu Subroto
[+](#) Open abstract [View article](#) [PDF](#)
-
- OPEN ACCESS** 012003
A Position Controller Model on Color-Based Object Tracking using Fuzzy Logic
Budi Cahyo Wibowo, Imam Much Ibnu Subroto and Bustanul Arifin
[+](#) Open abstract [View article](#) [PDF](#)
-
- OPEN ACCESS** 012004
Investigation of Diesel's Residual Noise on Predictive Vehicles Noise Cancelling using LMS Adaptive Algorithm
Sri Artini Dwi Prasetyowati, Adhi Susanto and Ida Widiastuti
[+](#) Open abstract [View article](#) [PDF](#)
-
- OPEN ACCESS** 012005
Quadrotor Proportional-Derivative Regulation for Nonzero Set Point on SO(3) with Disturbance Compensation
S Herdjunto, A P Sandiwan and A I Cahyadi
[+](#) Open abstract [View article](#) [PDF](#)
-
- OPEN ACCESS** 012006
Comparison of PID and Fuzzy Controller for Position Control of AR.Drone
A Prayitno, V Indrawati and I I Trusulaw
[+](#) Open abstract [View article](#) [PDF](#)
-
- OPEN ACCESS** 012007
Control of Liquid Sloshing Container using Active Force Control Method
Didik Setyo Purnomo, Adnan Rachmad Anom Besari and Zaqiatud Darojah
[+](#) Open abstract [View article](#) [PDF](#)
-
- OPEN ACCESS** 012008
Two-Link Flexible Manipulator Control Using Sliding Mode Control Based Linear Matrix Inequality
Zulfatman, Mohammad Marzuki and Nur Alif Mardiyah
[+](#) Open abstract [View article](#) [PDF](#)
-
- OPEN ACCESS** 012009
Lightweight UDP Pervasive Protocol in Smart Home Environment Based on Labview

Wijaya Kurniawan, Mochammad Hannats Hanafi Ichsan, Sabriansyah Rizzika Akbar and Issa Arwani

[+ Open abstract](#) [View article](#) [PDF](#)

OPEN ACCESS

012010

Cooperative Learning for Distributed In-Network Traffic Classification

S.B. Joseph, H.R. Loo, I. Ismail, T. Andromeda and M.N. Marsono

[+ Open abstract](#) [View article](#) [PDF](#)

OPEN ACCESS

012011

Monitoring and Identification Packet in Wireless With Deep Packet Inspection Method

Ahmad Fali Oklilas and Tasmi

[+ Open abstract](#) [View article](#) [PDF](#)

OPEN ACCESS

012012

Optimizing IT Infrastructure by Virtualization Approach

Thomas Budiman and Jarot S. Suroso

[+ Open abstract](#) [View article](#) [PDF](#)

OPEN ACCESS

012013

Comparison of Various Similarity Measures for Average Image Hash in Mobile Phone Application

Sam Farisa Chaerul Haviana and Muhammad Taufik

[+ Open abstract](#) [View article](#) [PDF](#)

OPEN ACCESS

012014

Real Time Monitoring System of Pollution Waste on Musi River Using Support Vector Machine (SVM) Method

Muhammad Fachrurrozi, Saparudin and Erwin

[+ Open abstract](#) [View article](#) [PDF](#)

OPEN ACCESS

012015

Fast Learning for Big Data Using Dynamic Function

T Alwajeeh, A F Alharthi, R F Rahmat and R Budiarto

[+ Open abstract](#) [View article](#) [PDF](#)

OPEN ACCESS

012016

Designing Business System Model using System Modeling Approach to the Small and Medium Enterprises (SME) of Furniture in Indonesia

Irwan Sukendar, Wiwiek Fatmawati, Imam Much Ibnu Subroto and Rizki Arigama

[+ Open abstract](#) [View article](#) [PDF](#)

-
- OPEN ACCESS** 012017
Joule-Thief Circuit Performance for Electricity Energy Saving of Emergency Lamps
Eka Nuryanto Budisusila and Bustanul Arifin
[+ Open abstract](#) [View article](#) [PDF](#)
-
- OPEN ACCESS** 012018
Development of Bio-impedance Analyzer (BIA) for Body Fat Calculation
Munawar A Riyadi, A Nugraha, M B Santoso, D Septaditya and T Prakoso
[+ Open abstract](#) [View article](#) [PDF](#)
-
- OPEN ACCESS** 012019
Investigation of Passive Filter for LED Lamp
Edi Sarwono, Mochammad Facta and Susatyo Handoko
[+ Open abstract](#) [View article](#) [PDF](#)
-
- OPEN ACCESS** 012020
Evaluation of skew-planar antenna for UAV communication at 2.4 GHz band
T Prakoso, A A Yaqin, Ibrahim, I Santoso, A Triwiyatno and M A Riyadi
[+ Open abstract](#) [View article](#) [PDF](#)
-
- OPEN ACCESS** 012021
A Comparisson of Synchronous And Nonsynchronous Boost Converter
Mohamad Isnaeni Romadhon, Trias Andromeda, Mochammad Facta and Agung Warsito
[+ Open abstract](#) [View article](#) [PDF](#)
-
- OPEN ACCESS** 012022
Geometrical Shape Investigation For Electrodes in Silent Discharge Chamber
Mochammad Facta, Ngurah Ayu Ketut Umiati and Agung Warsito
[+ Open abstract](#) [View article](#) [PDF](#)
-
- OPEN ACCESS** 012023
Implementation of Multipattern String Matching Accelerated with GPU for Intrusion Detection System
Rangga Nehemia, Charles Lim, Maulahikmah Galinium and Ahmad Rinaldi Widiyanto
[+ Open abstract](#) [View article](#) [PDF](#)
-
- OPEN ACCESS** 012024
Identification of electrical discharge on electric insulation material using acoustic emission method
J M Nainggolan, I Garniwa MK and A Raharjo

[+ Open abstract](#) [View article](#) [PDF](#)

OPEN ACCESS

012025

Determination of Hydrophobic Contact Angle of Epoxy Resin Compound Silicon Rubber and Silica

Abdul Syakur, Hermawan and Heri Sutanto

[+ Open abstract](#) [View article](#) [PDF](#)

OPEN ACCESS

012026

Statistical Analysis of Reducing Biochemical Oxygen Demand (BOD) on Industrial Rubber Wastewater using Dielectric Barrier Discharge Plasma

Abdul Syakur, Badrus Zaman and Dias Yunita Nurmaliakasih

[+ Open abstract](#) [View article](#) [PDF](#)

OPEN ACCESS

012027

Developing Control System of Electrical Devices with Operational Expense Prediction

Siti Sendari, Heru Wahyu Herwanto, Yuni Rahmawati, Dendi Mukti Putranto and Shofiana Fitri

[+ Open abstract](#) [View article](#) [PDF](#)

OPEN ACCESS

012028

Social Media Success for Academic Knowledge Sharing in Indonesia (Conceptual Model Development)

Setiawan Assegaff

[+ Open abstract](#) [View article](#) [PDF](#)

OPEN ACCESS

012029

Information Framework of Pervasive Real Time Monitoring System: Case of Peat Land Forest Fires and Air Quality in South Sumatera, Indonesia

Siti Nurmaini, Reza Firsandaya Malik, Deris Stiawan, Firdaus, Saparudin and Bambang Tutuko

[+ Open abstract](#) [View article](#) [PDF](#)

OPEN ACCESS

012030

Designing Albaha Internet of Farming Architecture

A Alahmadi

[+ Open abstract](#) [View article](#) [PDF](#)

OPEN ACCESS

012031

Detection Learning Style Vark For Out Of School Children (OSC)

Ali Amran, Anita Desiani and MS Hasibuan

[+ Open abstract](#) [View article](#) [PDF](#)

-
- OPEN ACCESS** 012032
Study of Smart Campus Development Using Internet of Things Technology
Marti Widya Sari, Prahenusa Wahyu Ciptadi and R. Hafid Hardyanto
[+](#) [Open abstract](#) [View article](#) [PDF](#)
-
- OPEN ACCESS** 012033
Model of load balancing using reliable algorithm with multi-agent system
M F Afriansyah, M Somantri and M A Riyadi
[+](#) [Open abstract](#) [View article](#) [PDF](#)
-
- OPEN ACCESS** 012034
Root Cause Failure Analysis of Stator Winding Insulation failure on 6.2 MW hydropower generator
Agus Adhi Nugroho, Ida Widiastuti and As Ary
[+](#) [Open abstract](#) [View article](#) [PDF](#)
-
- OPEN ACCESS** 012035
The Effects of Cells Temperature Increment and Variations of Irradiation for Monocrystalline Photovoltaic
Faishal Fuad Rahman Soeharto and Hermawan
[+](#) [Open abstract](#) [View article](#) [PDF](#)
-
- OPEN ACCESS** 012036
Water Pipeline Monitoring and Leak Detection using Flow Liquid Meter Sensor
R F Rahmat, I S Satria, B Siregar and R Budiarto
[+](#) [Open abstract](#) [View article](#) [PDF](#)
-
- OPEN ACCESS** 012037
Segmentation and classification models validation area mapping of peat lands as initial value of Fuzzy Kohonen Clustering Network
Erwin, Saparudin and Muhammad Fachrurrozi
[+](#) [Open abstract](#) [View article](#) [PDF](#)
-
- OPEN ACCESS** 012038
Implementation of 128 bits Camellia Algorithm for Cryptography in Digital Image
Bagus Satrio Waluyo Poetro
[+](#) [Open abstract](#) [View article](#) [PDF](#)
-
- OPEN ACCESS** 012039
The Automation System Censor Speech for the Indonesian Rude Swear Words Based on Support Vector Machine and Pitch Analysis

S N Endah, D M K Nugraheni, S Adhy and Sutikno

[+ Open abstract](#) [View article](#) [PDF](#)

OPEN ACCESS

012040

Noise Reduction in Breath Sound Files Using Wavelet Transform Based Filter

M F Syahputra, S I G Situmeang, R F Rahmat and R Budiarto

[+ Open abstract](#) [View article](#) [PDF](#)

OPEN ACCESS

012041

Tongue Segmentation Using Active Contour Model

Saparudin, Erwin and Muhammad Fachrurrozi

[+ Open abstract](#) [View article](#) [PDF](#)

OPEN ACCESS

012042

A Framework for Remote Monitoring System

Cahyo Crysdiان

[+ Open abstract](#) [View article](#) [PDF](#)

OPEN ACCESS

012043

Utilization of Digital Image Processing In Process of Quality Control of The Primary Packaging of Drug Using Color Normalization Method

Danang Erwanto, Sri Artini Dwi Prasetyowati and Eka Nuryanto Budi Susila

[+ Open abstract](#) [View article](#) [PDF](#)

OPEN ACCESS

012044

The Analysis of Alpha Beta Pruning and MTD(f) Algorithm to Determine the Best Algorithm to be Implemented at Connect Four Prototype

Lukas Tommy, Mardi Hardjianto and Nazori Agani

[+ Open abstract](#) [View article](#) [PDF](#)

OPEN ACCESS

012045

Optimizing Subgroups Formation for E-MBMS Transmissions in LTE Networks

M Algharem, M H Omar, D Stiawan and R Budiarto

[+ Open abstract](#) [View article](#) [PDF](#)

OPEN ACCESS

012046

The Performance Of SISO In Wireless Open-Access Research Platform (WARP) Using QAM Modulation

Jenny Putri Hapsari and Ida Anisah

[+ Open abstract](#) [View article](#) [PDF](#)

OPEN ACCESS

012047

Quality Test of Flexible Flat Cable (FFC) With Short Open Test Using Law Ohm Approach through Embedded Fuzzy Logic Based On Open Source Arduino Data Logger

Ajar Rohmanu and Yan Everhard

[+](#) Open abstract [View article](#) [PDF](#)

OPEN ACCESS

012048

Automatic Text Summarization for Indonesian Language Using TextTeaser

D Gunawan, A Pasaribu, R F Rahmat and R Budiarto

[+](#) Open abstract [View article](#) [PDF](#)

OPEN ACCESS

012049

Organization Readiness and ERP Implementation in Albaha University

K Alaqeel, M S Shakkah, R F Rahmat, A Alfageeh and R Budiarto

[+](#) Open abstract [View article](#) [PDF](#)

OPEN ACCESS

012050

Formulation of Policy for Cyber Crime in Criminal Law Revision Concept of Bill Book of Criminal Law (A New Penal Code)

Eko Sopyonyono and Brav Deva Bernadhi

[+](#) Open abstract [View article](#) [PDF](#)

JOURNAL LINKS

Journal home

Journal scope

Information for organizers

Information for authors

Contact us

Reprint services from Curran Associates

also developed by scimago:



SCIMAGO INSTITUTIONS RANKINGS

SJR

Scimago Journal & Country Rank

Enter Journal Title, ISSN or Publisher Name

[Home](#)[Journal Rankings](#)[Country Rankings](#)[Viz Tools](#)[Help](#)[About Us](#)

IOP Conference Series: Materials Science and Engineering

Discontinued in Scopus as of 2021

COUNTRY

[United Kingdom](#)



Universities and research
institutions in United Kingdom

SUBJECT AREA AND CATEGORY

[Engineering](#)
[Engineering](#)
(miscellaneous)

[Materials Science](#)
[Materials Science](#)
(miscellaneous)

PUBLISHER

[IOP Publishing Ltd.](#)

H-INDEX

44

PUBLICATION TYPE

Conferences and Proceedings

ISSN

17578981, 1757899X

COVERAGE

2009-2020

INFORMATION

[Homepage](#)

[How to publish in this
journal](#)

mse@iop.org



SCOPE

The open access IOP Conference Series provides a fast, versatile and cost-effective proceedings publication service for your conference. Key publishing subject areas include: physics, materials science, environmental science, bioscience, engineering, computational science and mathematics.

 Join the conversation about this journal

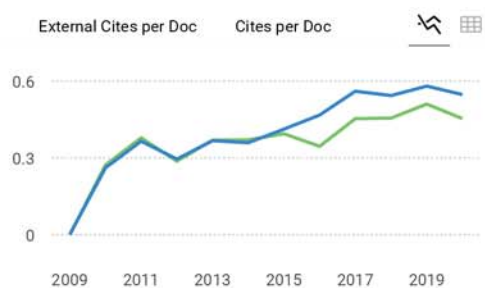
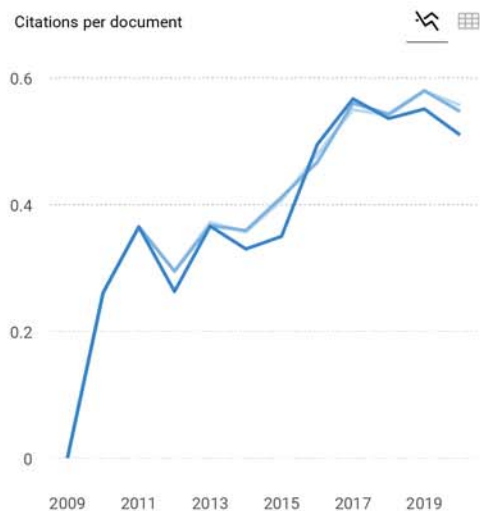
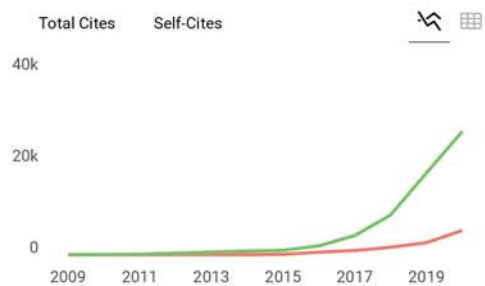
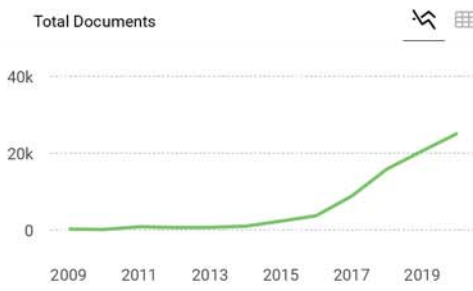
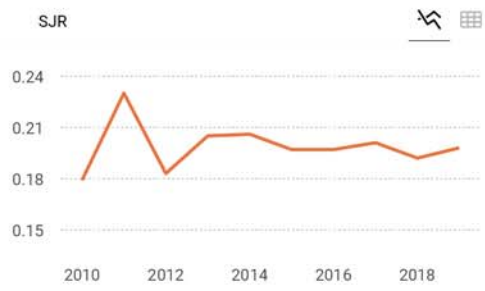

● Cites / Doc. (4 years)
● Cites / Doc. (3 years)
● Cites / Doc. (2 years)

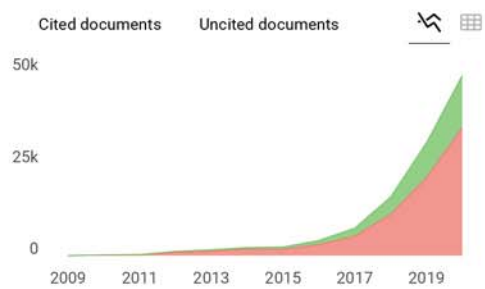
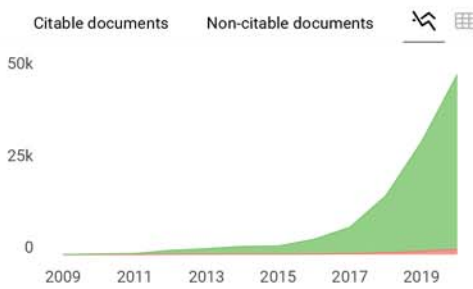
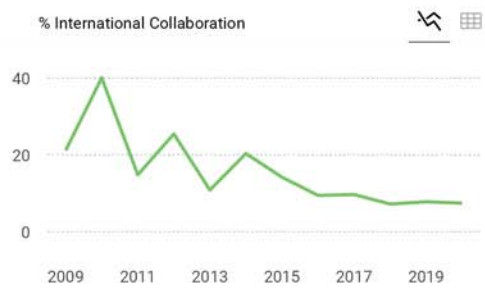

IOP Conference Series: Materials Science and...

Not yet assigned quartile

SJR 2020
0

powered by scimagojr.com

← Show this widget in your own website

Just copy the code below and paste within your html code:

```
<a href="https://www.scimagojr.com" style="border: 1px solid gray; padding: 2px;">

```

SCImago Graphica

Explore, visually communicate and make sense of data with our **new free tool**.

Get it





Source details

IOP Conference Series: Materials Science and Engineering

Scopus coverage years: from 2009 to 2021

(coverage discontinued in Scopus)

ISSN: 1757-8981 E-ISSN: 1757-899X

Subject area: Engineering: General Engineering Materials Science: General Materials Science

Source type: Conference Proceeding

CiteScore 2020

0.7



SJR 2019

0.198



SNIP 2020

0.484



[View all documents >](#)

[Set document alert](#)

[Save to source list](#) [Source Homepage](#)

[CiteScore](#) [CiteScore rank & trend](#) [Scopus content coverage](#)

i Improved CiteScore methodology



CiteScore 2020 counts the citations received in 2017-2020 to articles, reviews, conference papers, book chapters and data papers published in 2017-2020, and divides this by the number of publications published in 2017-2020. [Learn more >](#)

CiteScore 2020

$$0.7 = \frac{49,696 \text{ Citations } 2017 - 2020}{68,224 \text{ Documents } 2017 - 2020}$$

Calculated on 05 May, 2021

CiteScoreTracker 2021

$$1.1 = \frac{67,190 \text{ Citations to date}}{62,145 \text{ Documents to date}}$$

Last updated on 06 March, 2022 • Updated monthly

CiteScore rank 2020

Category	Rank	Percentile
Engineering		
General Engineering	#228/297	23rd
Materials Science		
General Materials Science	#381/455	16th

[View CiteScore methodology >](#) [CiteScore FAQ >](#) [Add CiteScore to your site](#)

About Scopus

- [What is Scopus](#)
- [Content coverage](#)
- [Scopus blog](#)
- [Scopus API](#)
- [Privacy matters](#)

Language

- [日本語に切り替える](#)
- [切换到简体中文](#)
- [切换到繁體中文](#)
- [Русский язык](#)

Customer Service

- [Help](#)
- [Tutorials](#)
- [Contact us](#)

ELSEVIER

[Terms and conditions](#) ↗ [Privacy policy](#) ↗

Copyright © Elsevier B.V. ↗. All rights reserved. Scopus® is a registered trademark of Elsevier B.V.

We use cookies to help provide and enhance our service and tailor content. By continuing, you agree to the use of cookies.

